

0	14.09.2001	ISSUED	An. T.	Al. T.	A. M.
Rev.	Date	Description	Drawn	Checked	Approved
CACCIALANZA & C. <small>s.p.a.</small> ANTINCENDIO SICUREZZA ANTINQUINAMENTO SEGRATE (MILAND) - ITALY		Client / Project			
		Title			
	Date	Name	PANEL 1 MONITOR (2 MOV.)		
Drawn	14.09.2001	An. T.	LKS6 STANDARD EXECUTION		
Checked	14.09.2001	Al. T.			
Approved	14.09.2001	A. M.			
Code	Sys.	Size	Scale	Dwg nr.	Rev.
		A 3	/	46413101	0
		Sheet	1		of
				10	
THIS DRAWING IS THE PROPERTY OF CACCIALANZA & C. S.p.A. AND IS NOT TO BE REPRODUCED OR USED TO FURNISH ANY INFORMATION FOR MAKING OF DRAWINGS OR APPARATUS EXCEPT WHERE PROVIDED FOR BY AGREEMENT WITH SAID COMPANY					

a b c d e f g h i j k m n p q r

0
1
2
3
4
5
6
7
8
9

PANEL BOARD TECHNICAL DATA		
RATED SERVICE VOLTAGE:.....400V	TYPE OF SEGREGATION:.....FORM 1	TEMPERATURE:.....40°C
RATED INSULATION VOLTAGE:.....1000V	INSTALLATION:.....OUTDOOR	DEGREE OF PROTECTION:see page 9
RATED FREQUENCY:.....50Hz	COMPLIANCE WITH STANDARD:.....CEI 17/13.1	COLOR:.....RED RAL3000
ELECTRICAL SYSTEM:.....3Ph+PE	IN/OUT CABLES:.....BOTTOM	

CACCIALANZA & C. s.p.a
 ANTINCENDIO SICUREZZA ANTINQUINAMENTO
 SEGRATE (MILANO) - ITALY

TITLE
MONITOR 2 MOTIONS
 TYPE A2-A4-A6-A8/EL

CLIENT

			DATE	14.09.2001	DWG N°	46413101
			SCALE	/		
			DRAWN	An.T.	PROJECT N°	
0	ISSUED	14.09.01	CHECKED	ALT.		
REV.	MODIFY	DATE	APPROVED	A.M.	SHEET N°	3 OF 10

a b c d e f g h i j k m n p q r

0
1
2
3
4
5
6
7
8
9

POWER CIRCUIT		AUXILIARY CIRCUIT	
MIN. SECTION 2,5mmq		MIN. SECTION 1,5mmq	
CONDUCTOR		CONDUCTOR	
PHASES	BLACK	24V - C.A.	RED
NEUTRAL	LIGHT BLUE	110V - A.C	RED
GROUND	YELLOW-GREEN	220V - A.C	BLACK
		24V - D.C	BLUE
WIRE COLOUR TABLE			

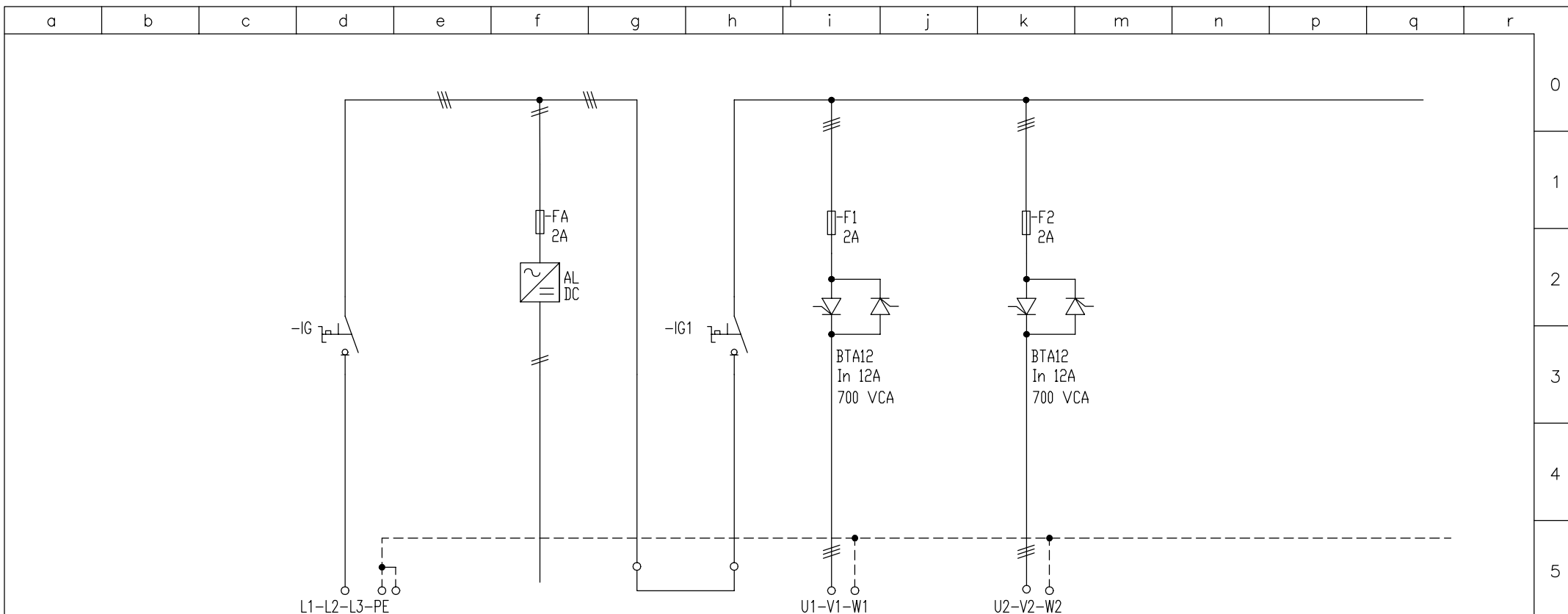

USE	CIRCUIT		n?		MAIN SUPPLY		RIGHT/LEFT MONITOR M01.1		UP/DOWN MONITOR M01.2	
	DESCRIPTION		Kw	A	1	2	0,45	0,9	0,45	0,9
ELECTRICAL EQUIPMENT	RATED SERVICE POWER AND CURRENT		Kw	A						
			Kw	A	1	2	0,45	0,9	0,45	0,9
	SWITCH	TYPE			P1-25	Z	
		RATED CURRENT - N. POLES	A	n?	25	3				
		BREAKING CAPACITY	V	KA	400					
		SETTING CURRENT MAG. ELEMENT	A							
		SETTING CURRENT THE. ELEMENT	A							
	CON-FACTOR	SETTING CURRENT Id	A							
		TYPE					DILER40/G(24VDC)		DILER40/G(24VDC)	
		RATED CURRENT	A							
THERMAL RELAY	UTILIZATION CATEGORY					AC-3		AC-3		
	TYPE									
	SETTING RANGE	A								
FUSEHOLDER	SETTING CURRENT	A								
	FUSEHOLDER - TYPE & CURRENT	A								
FUSES	FUSES - TYPE & SETTING CURRENT	A								
	AMMETER									
LINE	VOLMETER									
	CABLE	TYPE								
		SECTION	mmq				(4G2,5)		(4G2,5)	
		LANGE	mt							
RATED CURRENT(Iz)		A								

CACCIALANZA & C. s.p.a.
 ANTINCENDIO SICUREZZA ANTINQUINAMENTO
 SEGRATE (MILAND) - ITALY

TITLE
MONITOR 2 MOTIONS
 TYPE A2-A4-A6-A8/EL

CLIENT

DATE	14.09.2001	DWG N°	46413101
SCALE	/	PROJECT N°	
DRAWN	An.T.		
0 ISSUED	14.09.01	CHECKED	AL.T.
REV.	MODIFY	DATE	APPROVED A.M.
		SHEET N°	5 OF 10

a b c d e f g h i j k m n p q r

TO UZM-1 PANEL

UZM-2 PANEL

CAVO TIPO

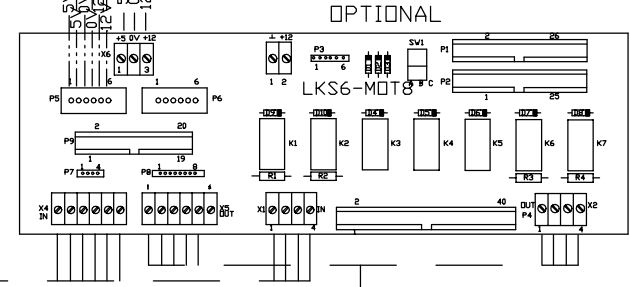
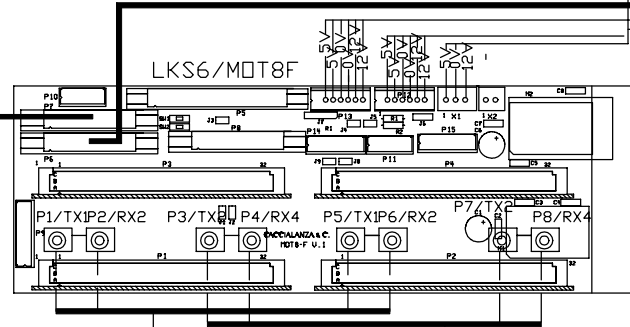
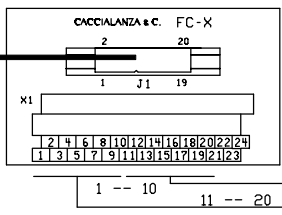

12V BATT.

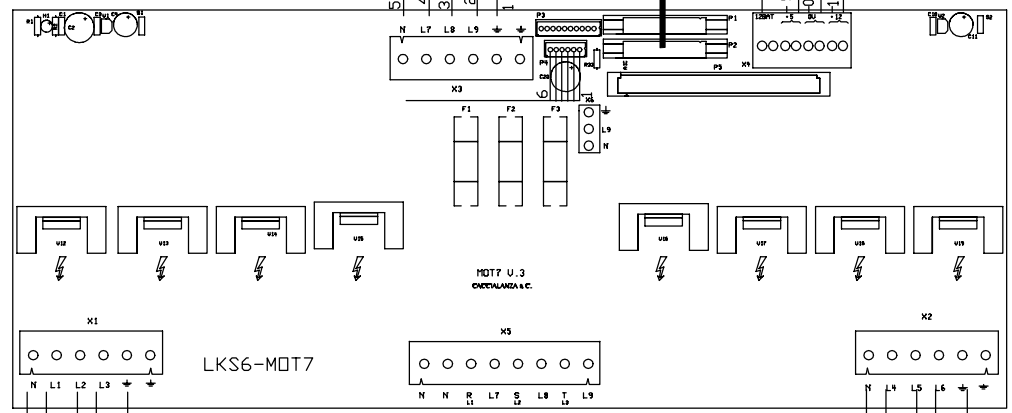

CABLE "IN" LOOP

CABLE "OUT" LOOP

CACCIALANZA & C. S.p.A
ANTINCENDIO SICUREZZA ANTINQUINAMENTO
SEGRATE (MILAND) - ITALY

TITLE
MONITOR 2 MOTIONS
TYPE A2-A4-A6-A8/EL

CLIENT

DATE	14.09.2001
SCALE	/
DRAWN	An.T.
CHECKED	AL.T.
APPROVED	A.M.
DATE	14.09.01
REV.	0 ISSUED
DATE	14.09.01
REV.	MODIFY

DWG N° 46413101
PROJECT N°
SHEET N. 6 OF 10

UZM-1 PANEL

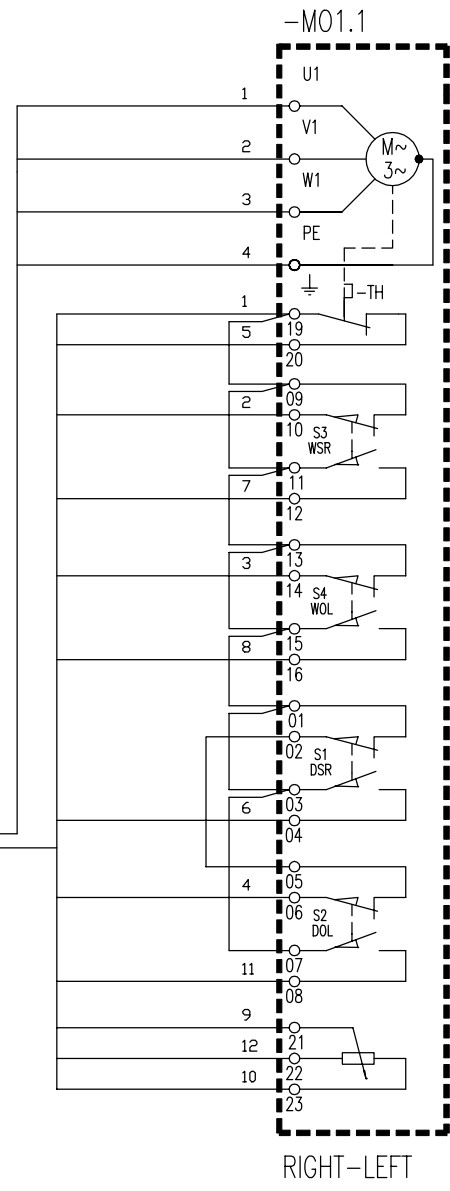
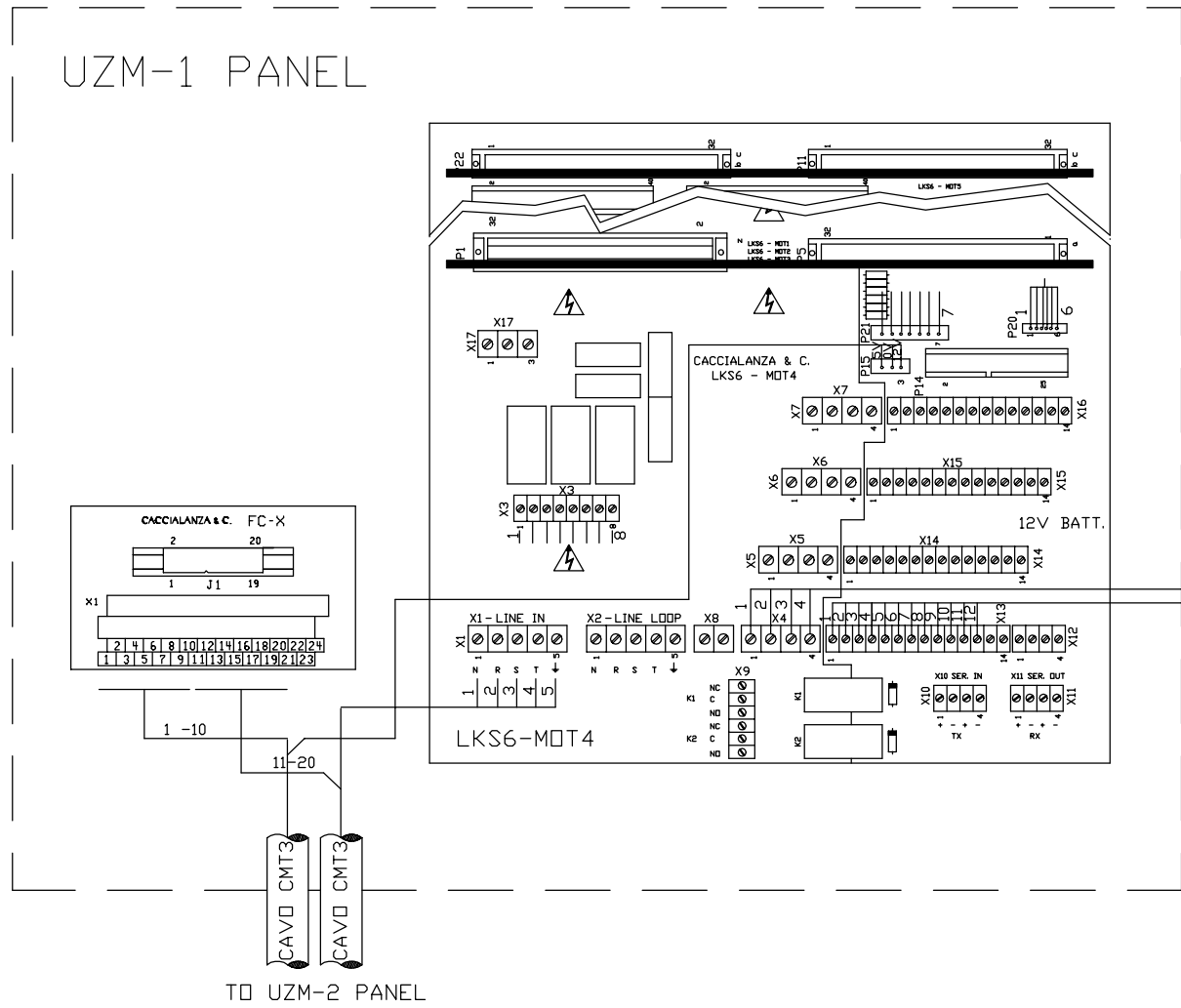

UZM-1 PANEL

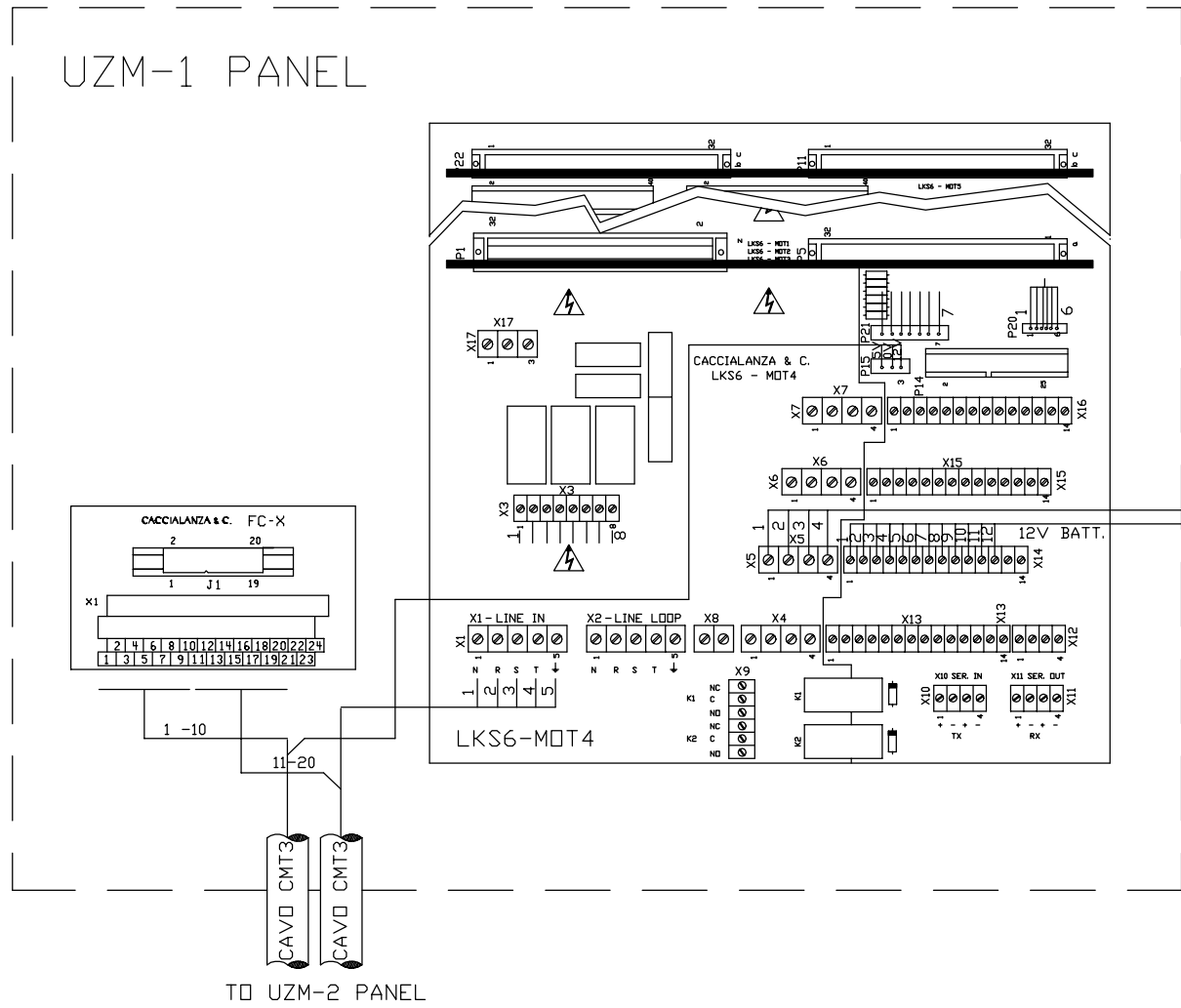

TO UZM-2 PANEL

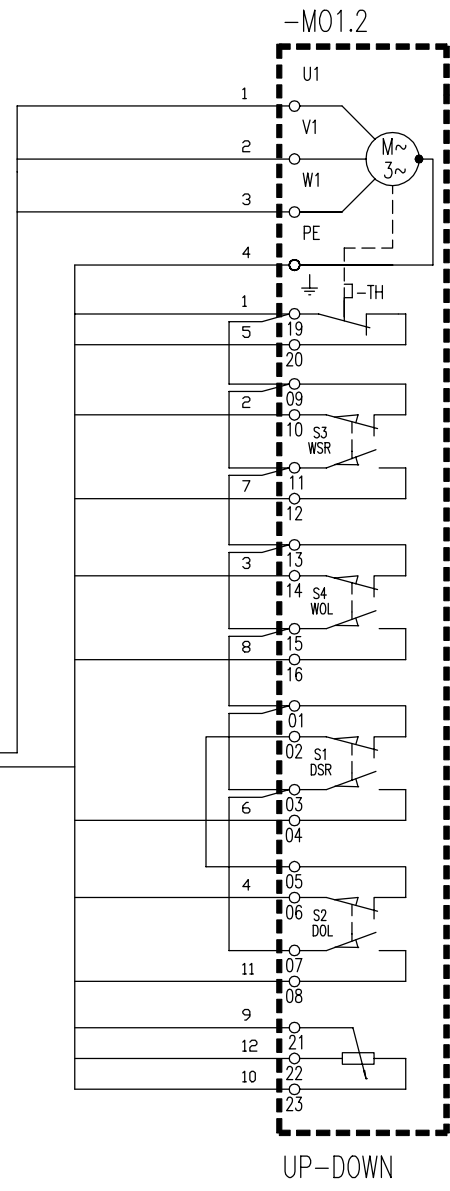

UP-DOWN

CACCIALANZA & C. S.p.A.
 ANTINCENDIO SICUREZZA ANTINQUINAMENTO
 SEGRATE (MILAND) - ITALY

TITLE
 MONITOR 2 MOTIONS
 TYPE A2-A4-A6-A8/EL

CLIENT

DATE	14.09.2001
SCALE	/
DRAWN	An.T.
CHECKED	AL.T.
DATE	14.09.01
APPROVED	A.M.

DWG N° 46413101
 PROJECT N°
 SHEET N. 8 OF 10

0
1
2
3
4
5
6
7
8
9

a b c d e f g h i j k m n p q r

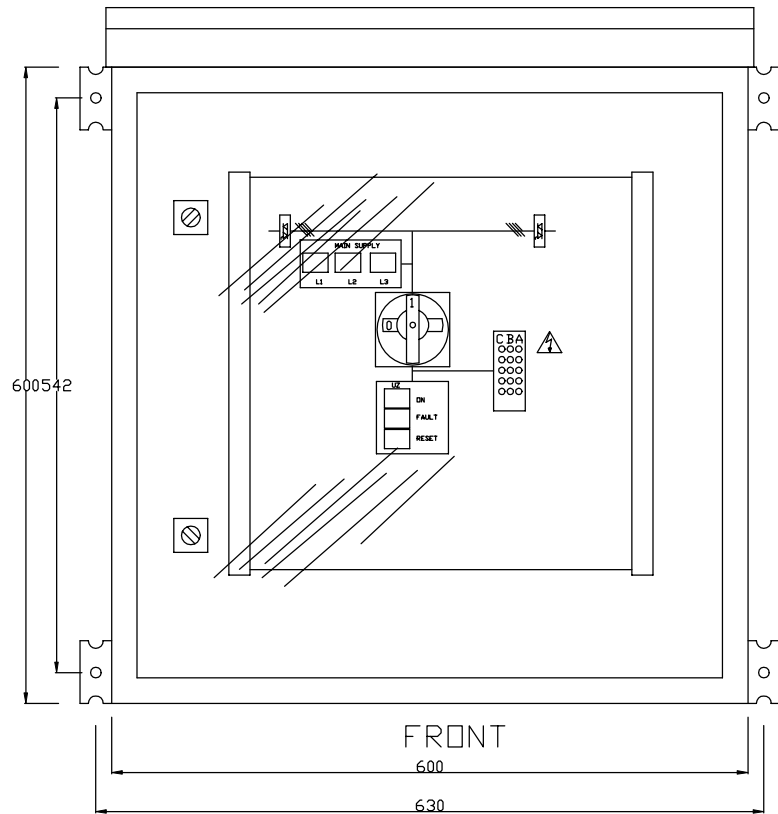

PLATE

SEE DWG. EJ071304

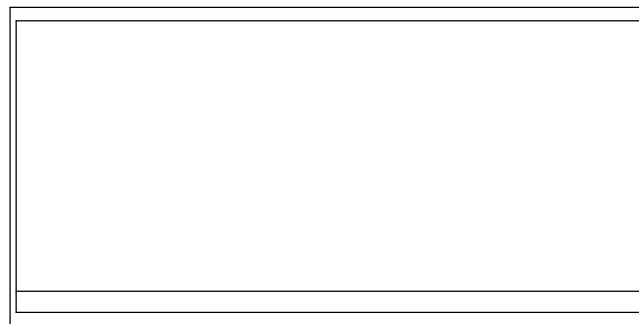
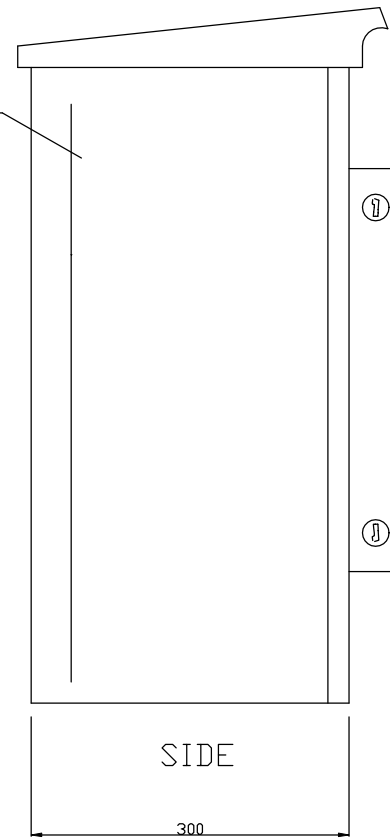

0
1
2
3
4
5
6
7
8
9

CACCIALANZA & C. s.p.a
 ANTINCENDIO SICUREZZA ANTINQUINAMENTO
 SEGRATE (MILANO) - ITALY

TITLE
MONITOR 2 MOTIONS
 TYPE A2-A4-A6-A8/EL

CLIENT

			DATE	14.09.2001	DWG N°	46414101
			SCALE	/	PROJECT N°	
			DRAWN	An.T.		
0	ISSUED	14.09.01	CHECKED	ALT.		
REV.	MODIFY	DATE	APPROVED	A.M.	SHEET N°	9 OF 10

a b c d e f g h i j k m n p q r

SEALED HEATH EXCHANGER

FRONT

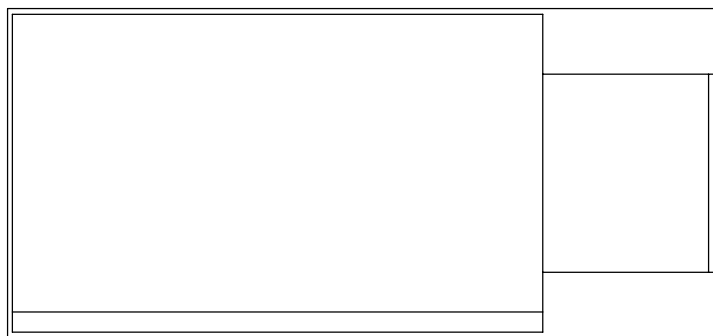
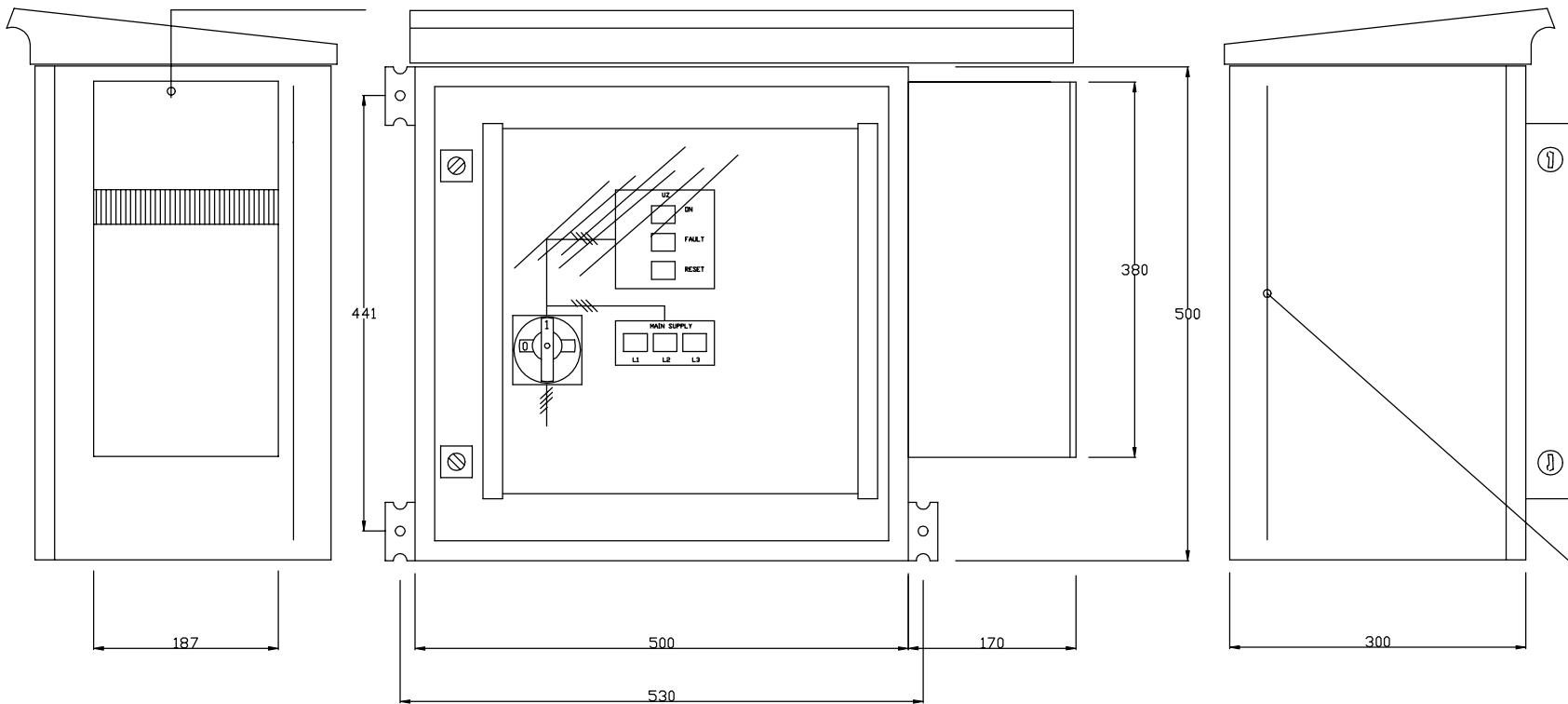

PLANT

PLATE
SEE DWG. EJ071302

CACCIALANZA & C. S.p.A.
ANTINCENDIO SICUREZZA ANTINQUINAMENTO
SEGRATE (MILANO) - ITALY

TITLE
MONITOR 2 MOTIONS
TYPE A2-A4-A6-A8/EL

CLIENT

			DATE	14.09.2001	DWG N°	46414101
			SCALE	/	PROJECT N°	
			DRAWN	An.T.		
			CHECKED	AL.T.		
REV.	MODIFY	DATE	APPROVED	A.M.	SHEET N°.	10 OF 10

0
1
2
3
4
5
6
7
8
9